

Arthroscopy

Arthroscopes	wide angle	I=110 mm
Ø 2.7 mm	0°	10-0001-00
Ø 2.7 mm	30°	10-0002-00
Ø 2.7 mm	70°	10-0003-00

autoclavable (134°C/273°F)

Arthroscopes	wide angle	I=175 mm
Ø 2.7 mm	0°	10-0004-00
Ø 2.7 mm	30°	10-0005-00
Ø 2.7 mm	70°	10-0006-00

autoclavable (134°C/273°F)

Arthroscopes	wide angle	I=187.5 mm
Ø 2.7 mm	0°	10-0007-00
Ø 2.7 mm	30°	10-0008-00
Ø 2.7 mm	70°	10-0009-00

autoclavable (134°C/273°F)

Arthroscopes	wide angle	I=142 mm
Ø 4 mm	30°	10-0091-00

autoclavable (134°C/273°F)

Arthroscopes	wide angle	I=175 mm
Ø 4 mm	0°	10-0010-00
Ø 4 mm	30°	10-0011-00
Ø 4 mm	45°	10-0085-00
Ø 4 mm	70°	10-0012-00

autoclavable (134°C/273°F)

For any further requirements please don't hesitate to contact us. We are able to design any endoscopic product specific to your needs.

Trokarhülsen, Obturatoren (Arthroskopie) Trocar Sheaths, Obturators (Arthroscopy)

Arthroskopie Trokar, fest, ein Hahn
Arthroscopy Trocar, fixed, one Stopcock

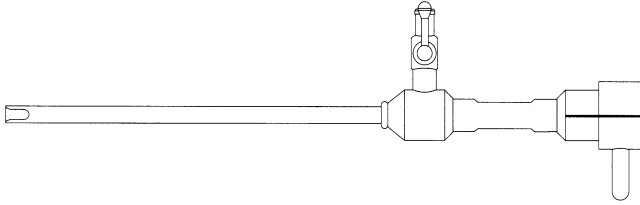

Ø 2,7 mm	L=110 mm	24.1403.00
Ø 2,7 mm	L=175 mm	24.1404.00
Ø 2,7 mm	L=187,5 mm	24.1405.00
Ø 4,0 mm	L=175 mm	24.1406.00
Ø 5,0 mm	L=175 mm	24.1407.00

Arthroskopie Trokar, fest, zwei Hähne
Arthroscopy Trocar, fixed, two Stopcocks

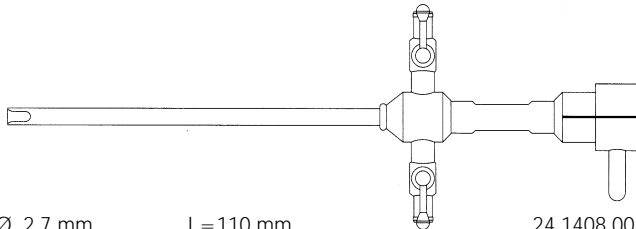

Ø 2,7 mm	L=110 mm	24.1408.00
Ø 2,7 mm	L=175 mm	24.1409.00
Ø 2,7 mm	L=187,5 mm	24.1410.00
Ø 4,0 mm	L=175 mm	24.1411.00
Ø 5,0 mm	L=175 mm	24.1412.00

Arthroskopie Trokar, drehbar, ein Hahn
Arthroscopy Trocar, rotatable, one Stopcock

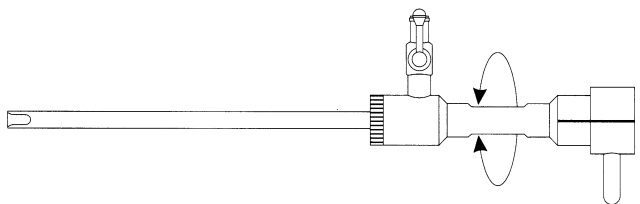

Ø 2,7 mm	L=110 mm	24.1413.00
Ø 2,7 mm	L=175 mm	24.1414.00
Ø 2,7 mm	L=187,5 mm	24.1415.00
Ø 4,0 mm	L=175 mm	24.1416.00
Ø 5,0 mm	L=175 mm	24.1417.00

Arthroskopie Trokar, drehbar, zwei Hähne
Arthroscopy Trocar, rotatable, two Stopcocks

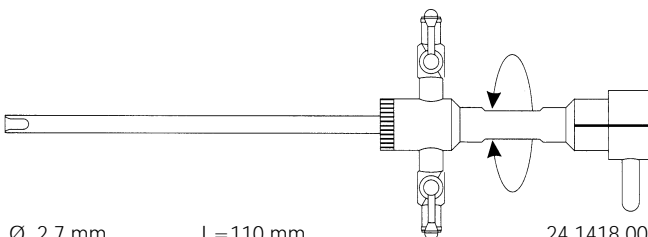

Ø 2,7 mm	L=110 mm	24.1418.00
Ø 2,7 mm	L=175 mm	24.1419.00
Ø 2,7 mm	L=187,5 mm	24.1420.00
Ø 4,0 mm	L=175 mm	24.1421.00
Ø 5,0 mm	L=175 mm	24.1422.00

Obturator, spitz - Obturator, sharp

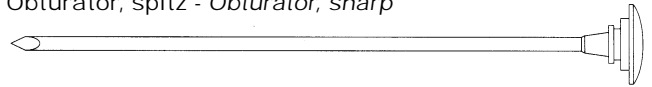

Ø 2,7 mm	L=110 mm	24.1423.00
Ø 2,7 mm	L=175 mm	24.1424.00
Ø 2,7 mm	L=187,5 mm	24.1425.00
Ø 4,0 mm	L=175 mm	24.1426.00
Ø 5,0 mm	L=175 mm	24.1427.00

Obturator, stumpf - Obturator, blunt

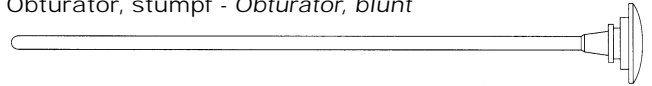

Ø 2,7 mm	L=110 mm	24.1428.00
Ø 2,7 mm	L=175 mm	24.1429.00
Ø 2,7 mm	L=187,5 mm	24.1430.00
Ø 4,0 mm	L=175 mm	24.1431.00
Ø 5,0 mm	L=175 mm	24.1432.00

Modulares Arthroskopie Saug- und Spülsystem bestehend aus Schaft und Handgriff

Modular Arthroscopy Suction and Irrigation System consting of Sheath and Handle



Modularer Arthroskopie Saug- und Spülschaft
Modular Arthroscopy Suction and Irrigation Sheath

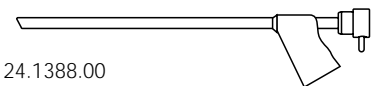

Zur Verwendung mit Handgriff 24.1388.00
For use with Handle 24.1388.00

für Optik Ø 2,7 mm, L=187,5 mm <i>for Scopes Ø 2,7 mm, l=187,5mm</i>	für Optik Ø 4 mm, L=175 mm <i>for Scopes Ø 4 mm, l=175 mm</i>
0° - 30° 24.1389.00	0° - 30° 24.1391.00
70° 24.1390.00	70° 24.1392.00

Obturator - Obturator
für 24.1389.00 und 24.1390.00
for 24.1389.00 and 24.1390.00

Obturator - Obturator
für 24.1391.00 und 24.1392.00
for 24.1391.00 and 24.1392.00

<i>spitz - sharp</i>	24.1433.00
<i>stumpf - blunt</i>	24.1434.00

<i>spitz - sharp</i>	24.1435.00
<i>stumpf - blunt</i>	24.1436.00

Modularer Saug- und Spülhandgriff
Modular Suction and Irrigation Handle

Zur Verwendung mit den Saug- und Spülschäften 24.1389.00 - 24.1392.00
For use with Suction and Irrigation Sheaths 24.1389.00 - 24.1392.00

24.1388.00

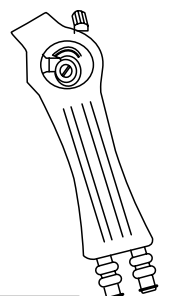

Trokare, Spülkanülen, Spülspritze (Arthroskopie) Trocars, Irrigation Cannulas, Irrigation Syringe (Arthroscopy)

A2

Trokar, spitz - Trocar, sharp

Ø 5,5 mm, Arbeitslänge 70 mm - Ø 5,5 mm, Working Length 70 mm

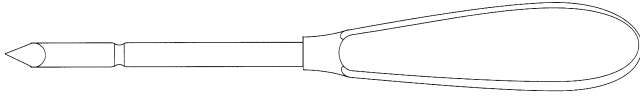

24.1437.00

Spülkanüle - Inflow Cannula

Ø 2,2 mm, Arbeitslänge 70 mm - Ø 2,2 mm, Working Length 70 mm

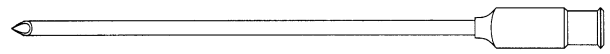

24.1440.00

Trokar, stumpf - Trocar, blunt

Ø 5,5 mm, Arbeitslänge 70 mm - Ø 5,5 mm, Working Length 70 mm

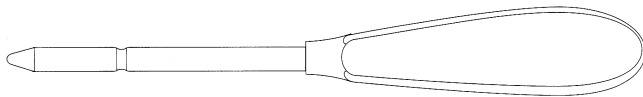

24.1438.00

Spülkanüle mit Obturator spitz

Inflow Cannula with Obturator sharp

Ø 3,2 mm, Arbeitslänge 70 mm - Ø 3,2 mm, Working Length 70 mm

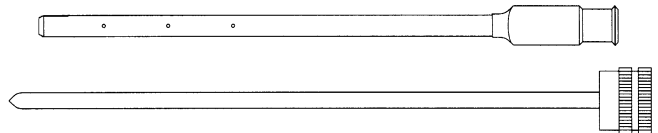

24.1441.00

Trokarhülse - Trocar Sheath

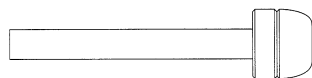

24.1439.00

Spülkanüle mit Hahn und Obturator spitz

Inflow Cannula with Stopcock and Obturator sharp

Ø 3,2 mm, Arbeitslänge 70 mm - Ø 3,2 mm, Working Length 70 mm

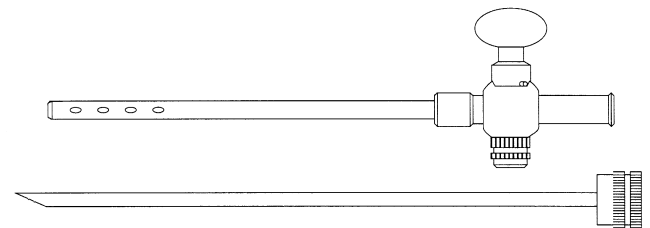



24.1442.00

Handinstrumente (Arthroskopie) Hand Instruments (Arthroscopy)

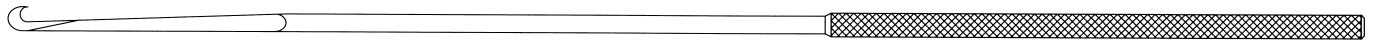

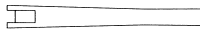
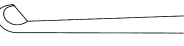
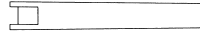
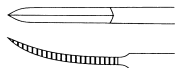
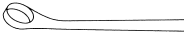
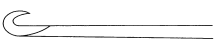
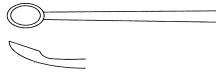

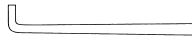



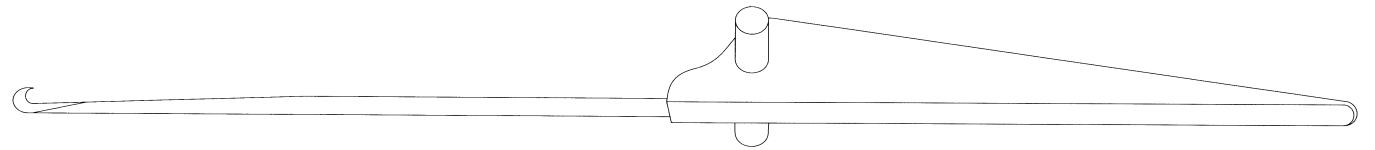

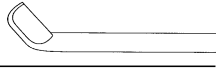
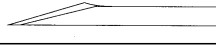
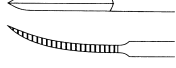
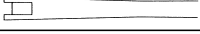
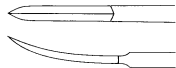

Instrumente einteilig, gerändelter Griff - Instruments one-piece, knurled Handle

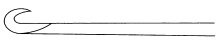
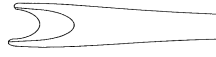

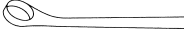
Messer, spitz - <i>Knife pointed</i> 24.1445.00		Meniskotom - <i>Meniscotome</i> Smillie 3 mm 24.1450.00	
Messer, retrograd - <i>Knife retrograd</i> 45° 24.1446.00		Smillie 5 mm 24.1451.00	
Bananenmesser, gezahnt <i>Banana Knife, serrated</i> 24.1447.00		Ringkürette, 3 mm, 30° <i>Ring Curette, 3 mm, 30°</i> 24.1452.00	
Hakenmesser - <i>Hook Knife</i> 3 mm, 90° 24.1448.00		Löffel, 3 mm, 30° <i>Spoon, 3 mm, 30°</i> 24.1453.00	
Rosettenmesser - <i>Rosette Knife</i> gerade - <i>straight</i> 24.1449.00		Hakensonde - <i>Hook Probe</i> 4 mm 24.1454.00	

Instrumente einteilig, massiver Dreieck-Griff - Instruments one-piece, solid Triangular Handle

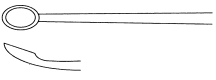

Messer, spitz - <i>Knife pointed</i> 24.1455.00		Sichelmesser - <i>Sickel Knife</i> 24.1464.00	
Messer, retrograd - <i>Knife retrograd</i> 45° 24.1456.00		Bajonettmesser - <i>Bajonett Knife</i> 24.1465.00	
Bananenmesser, gezahnt <i>Banana Knife, serrated</i> 24.1457.00		Meniskotom, gerade Schneide <i>Meniscotome, straight Edge</i> Smillie 3 mm 24.1466.00	
Bananenmesser, glatt <i>Banana Knife, smooth</i> 24.1458.00		Smillie 5 mm 24.1467.00	
Hakenmesser - <i>Hook Knife</i> 3 mm, 90° 24.1459.00		Meniskotom, runde Schneide <i>Meniscotome, round Edge</i> Smillie 7 mm 24.1468.00	
Rosettenmesser - <i>Rosette Knife</i> gerade - <i>straight</i> 24.1460.00		Ringkürette - <i>Ring Curette</i> 3 mm, 30° 24.1469.00	
30° rechts gebogen <i>30° right curved</i> 24.1461.00		7 mm, 30° 24.1470.00	
30° links gebogen <i>30° left curved</i> 24.1462.00		Hakensonde - <i>Hook Probe</i> spitz - <i>pointed</i> 24.1471.00	
Löffel, 3 mm, 30° <i>Spoon, 3 mm, 30°</i> 24.1463.00		2,5 mm 24.1472.00	
		3,5 mm 24.1473.00	

Handgriff mit auswechselbaren Aufsätzen (Arthroskopie) Handle with interchangeable Stems (Arthroscopy)

A4

Handgriff für Klick-Aufsätze - Handle for Click-Stems

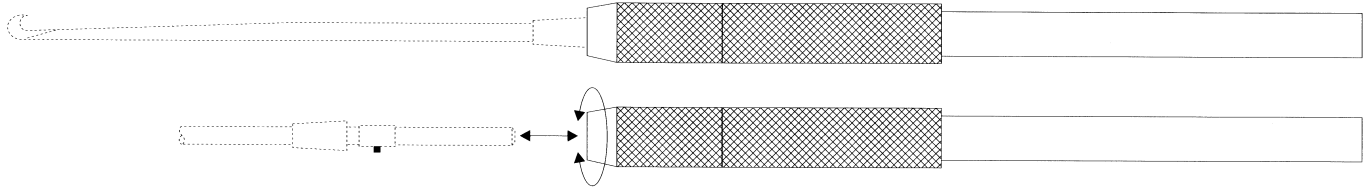

24.1474.00

Klick-Aufsätze - Click-Stems

Messer, spitz - *Knife pointed*
24.1475.00

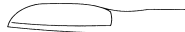

Meniskotom, gerade Schneide
Meniscomtome, straight Edge

Smillie 3 mm 24.1485.00

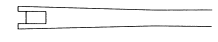

Bajonettmesser - *Bajonett Knife*
24.1476.00

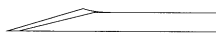

Smillie 5 mm 24.1486.00

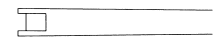

Sichelmesser - *Sickel Knife*
24.1477.00

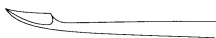

Meniskotom, runde Schneide
Meniscomtome, round Edge

Smillie 7 mm 24.1487.00

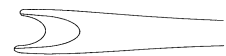

Messer, retrograd - *Knife retrograd*
45° 24.1478.00



Ringkürette - *Ring Curette*

3 mm, 30° 24.1488.00

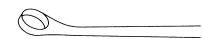

Bananenmesser, gezahnt
Banana Knife, serrated
24.1479.00

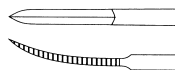

7 mm, 30° 24.1489.00



Bananenmesser, glatt
Banana Knife, smooth
24.1480.00

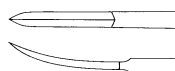

Rosettenmesser, gerade
Rosette Knife, straight
24.1490.00



Hakenmesser - *Hook Knife*
3 mm 90° 24.1481.00

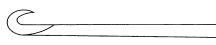

Rosettenmesser, 30° gebogen
Rosette Knife, 30° curved

rechts gebogen - *right curved* 24.1491.00



Hakensonde - *Hook Probe*
spitz - *pointed* 24.1482.00



links gebogen - *left curved* 24.1492.00

2,5 mm 24.1483.00



Löffel, 3 mm, 30°
Spoon, 3 mm, 30°

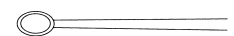

3,5 mm 24.1484.00



24.1493.00



Handgriff mit auswechselbaren Aufsätzen (Arthroskopie) Handle with interchangeable Stems (Arthroscopy)

A5

Handgriff für Aufsätze festdrehbar - Handle for Stems turned fixed

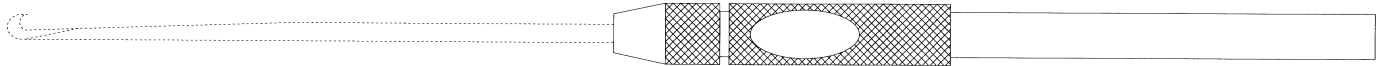

24.1494.00

Aufsätze - Stems

Messer, spitz - *Knife pointed*
24.1495.00

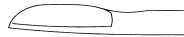

Bajonettmesser - *Bajonett Knife*
24.1496.00



Sichelmesser - *Sickel Knife*
24.1497.00



Messer, retrograd - *Knife retrograd*
45° 24.1498.00



Bananenmesser, gezahnt
Banana Knife, serrated
24.1499.00

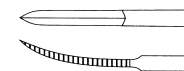

Bananenmesser, glatt
Banana Knife, smooth
24.1500.00

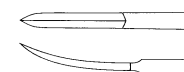

Hakenmesser - *Hook Knife*
3 mm 90° 24.1501.00

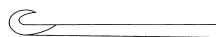

Hakensonde - *Hook Probe*
spitz - *pointed* 24.1502.00

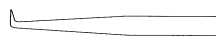

2,5 mm 24.1503.00



3,5 mm 24.1504.00



Meniskotom, gerade Schneide
Meniscotome, straight Edge

Smillie 3 mm 24.1505.00

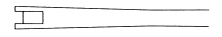

Smillie 5 mm 24.1506.00

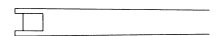

Meniskotom, runde Schneide
Meniscotome, round Edge

Smillie 7 mm 24.1507.00

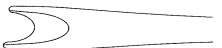

Ringkürette - *Ring Curette*

3 mm, 30° 24.1508.00

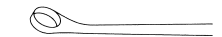

7 mm, 30° 24.1509.00



Rosettenmesser, gerade
Rosette Knife, straight
24.1510.00



Rosettenmesser, 30° gebogen
Rosette Knife, 30° curved

rechts gebogen - *right curved* 24.1511.00

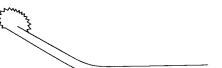

links gebogen - *left curved* 24.1512.00

Löffel, 3 mm, 30°
Spoon, 3 mm, 30°
24.1513.00

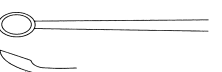

Hakenstanzen, Hakenscheren (Arthroskopie) Hook Punches, Hook Scissors (Arthroscopy)

A6

Griff ohne Feder
Handle without Spring

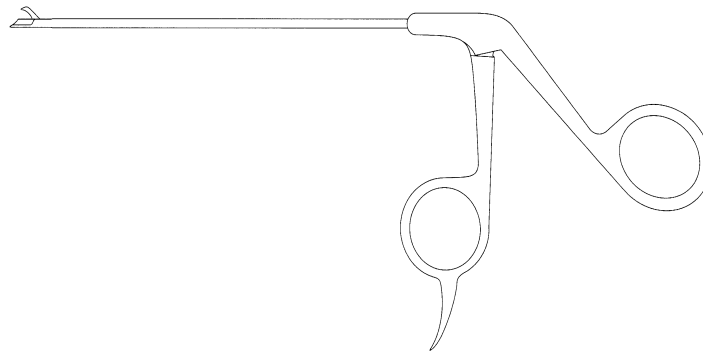

Hakenstanze mit Schaufel
Hook Punch with Scoop

Hakenstanze
Hook Punch

Hakenscheren
Hook Scissors

Arbeitslänge 130 mm
Working Length 130 mm

Ø

				
	2,7 mm gerade 0° - <i>straight 0°</i>	24.1514.00	24.1540.00	24.1566.00
	3,5 mm gerade 0° - <i>straight 0°</i>	24.1515.00	24.1541.00	24.1567.00
	2,7 mm 30° links gebogen - <i>30° left curved</i>	24.1516.00	24.1542.00	24.1568.00
	3,5 mm 30° links gebogen - <i>30° left curved</i>	24.1517.00	24.1543.00	24.1569.00
	2,7 mm 30° rechts gebogen - <i>30° right curved</i>	24.1518.00	24.1544.00	24.1570.00
	3,5 mm 30° rechts gebogen - <i>30° right curved</i>	24.1519.00	24.1545.00	24.1571.00
	2,7 mm 45° links gebogen - <i>45° left curved</i>	24.1520.00	24.1546.00	24.1572.00
	3,5 mm 45° links gebogen - <i>45° left curved</i>	24.1521.00	24.1547.00	24.1573.00
	2,7 mm 45° rechts gebogen - <i>45° right curved</i>	24.1522.00	24.1548.00	24.1574.00
	3,5 mm 45° rechts gebogen - <i>45° right curved</i>	24.1523.00	24.1549.00	24.1575.00
	2,7 mm 7° aufwärts gebogen - <i>7° upward curved</i>	24.1524.00	24.1550.00	24.1576.00
	3,5 mm 7° aufwärts gebogen - <i>7° upward curved</i>	24.1525.00	24.1551.00	24.1577.00
	2,7 mm 7° abwärts gebogen - <i>7° downward curved</i>	24.1526.00	24.1552.00	24.1578.00
	3,5 mm 7° abwärts gebogen - <i>7° downward curved</i>	24.1527.00	24.1553.00	24.1579.00
	2,7 mm 15° aufwärts gebogen - <i>15° upward curved</i>	24.1528.00	24.1554.00	24.1580.00
	3,5 mm 15° aufwärts gebogen - <i>15° upward curved</i>	24.1529.00	24.1555.00	24.1581.00
	2,7 mm 15° abwärts gebogen - <i>15° downward curved</i>	24.1530.00	24.1556.00	24.1582.00
	3,5 mm 15° abwärts gebogen - <i>15° downward curved</i>	24.1531.00	24.1557.00	24.1583.00
	3,5 mm 45° links gebogen (Spitze) - <i>45° left curved (tip)</i>	24.1533.00	24.1559.00	
	3,5 mm 45° rechts gebogen (Spitze) - <i>45° right curved (tip)</i>	24.1535.00	24.1561.00	
	3,5 mm 90° links gebogen (Spitze) - <i>90° left curved (tip)</i>	24.1537.00	24.1563.00	
	3,5 mm 90° rechts gebogen (Spitze) - <i>90° right curved (tip)</i>	24.1539.00	24.1565.00	

Hakenstanzen, Hakenscheren (Arthroskopie) Hook Punches, Hook Scissors (Arthroscopy)

Griff mit Feder
Handle with Spring

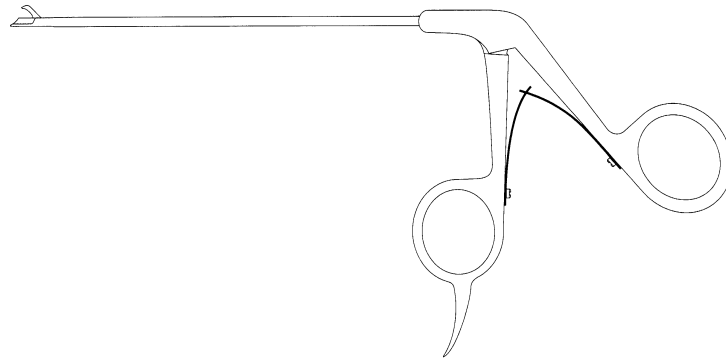

		Hakenstanze mit Schaufel Hook Punch with Scoop	Hakenstanze Hook Punch	Hakenschere Hook Scissors
Arbeitslänge 130 mm Working Length 130 mm				
Ø				
	0°	2,7 mm gerade 0° - <i>straight 0°</i>	24.1585.00	24.1611.00
		3,5 mm gerade 0° - <i>straight 0°</i>	24.1586.00	24.1612.00
	30°	2,7 mm 30° links gebogen - <i>30° left curved</i>	24.1587.00	24.1613.00
		3,5 mm 30° links gebogen - <i>30° left curved</i>	24.1588.00	24.1614.00
	30°	2,7 mm 30° rechts gebogen - <i>30° right curved</i>	24.1589.00	24.1615.00
		3,5 mm 30° rechts gebogen - <i>30° right curved</i>	24.1590.00	24.1616.00
	45°	2,7 mm 45° links gebogen - <i>45° left curved</i>	24.1591.00	24.1617.00
		3,5 mm 45° links gebogen - <i>45° left curved</i>	24.1592.00	24.1618.00
	45°	2,7 mm 45° rechts gebogen - <i>45° right curved</i>	24.1593.00	24.1619.00
		3,5 mm 45° rechts gebogen - <i>45° right curved</i>	24.1594.00	24.1620.00
	7°	2,7 mm 7° aufwärts gebogen - <i>7° upward curved</i>	24.1595.00	24.1621.00
		3,5 mm 7° aufwärts gebogen - <i>7° upward curved</i>	24.1596.00	24.1622.00
	7°	2,7 mm 7° abwärts gebogen - <i>7° downward curved</i>	24.1597.00	24.1623.00
		3,5 mm 7° abwärts gebogen - <i>7° downward curved</i>	24.1598.00	24.1624.00
	15°	2,7 mm 15° aufwärts gebogen - <i>15° upward curved</i>	24.1599.00	24.1625.00
		3,5 mm 15° aufwärts gebogen - <i>15° upward curved</i>	24.1600.00	24.1626.00
	15°	2,7 mm 15° abwärts gebogen - <i>15° downward curved</i>	24.1601.00	24.1627.00
		3,5 mm 15° abwärts gebogen - <i>15° downward curved</i>	24.1602.00	24.1628.00
	45°	3,5 mm 45° links gebogen (Spitze) - <i>45° left curved (tip)</i>	24.1604.00	24.1630.00
	45°	3,5 mm 45° rechts gebogen (Spitze) - <i>45° right curved (tip)</i>	24.1606.00	24.1632.00
	90°	3,5 mm 90° links gebogen (Spitze) - <i>90° left curved (tip)</i>	24.1608.00	24.1634.00
	90°	3,5 mm 90° rechts gebogen (Spitze) - <i>90° right curved (tip)</i>	24.1610.00	24.1636.00

Stanzen breit (Arthroskopie) Punches wide (Arthroscopy)

A8

Griff ohne Feder
Handle without Spring

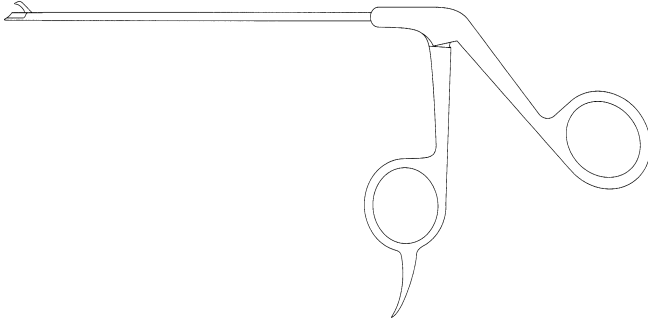

Griff mit Feder
Handle with Spring

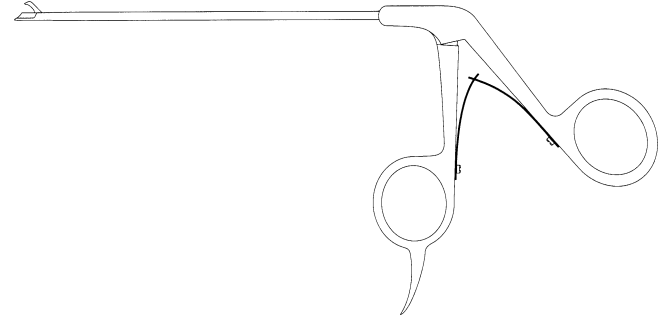

Stanze, schlank
Punch, slender

Ø 3,4 mm, Arbeitslänge 130 mm
Ø 3,4 mm, Working Length 130 mm



gerade 0° - straight 0°	24.1656.00
30° links gebogen - 30° left curved	24.1657.00
30° rechts gebogen - 30° right curved	24.1658.00
45° links gebogen - 45° left curved	24.1659.00
45° rechts gebogen - 45° right curved	24.1660.00
7° aufwärts gebogen - 7° upward curved	24.1661.00
7° abwärts gebogen - 7° downward curved	24.1662.00
15° aufwärts gebogen - 15° upward curved	24.1663.00
15° abwärts gebogen - 15° downward curved	24.1664.00

Stanze, schlank
Punch, slender

Ø 3,4 mm, Arbeitslänge 130 mm
Ø 3,4 mm, Working Length 130 mm



gerade 0° - straight 0°	24.1668.00
30° links gebogen - 30° left curved	24.1669.00
30° rechts gebogen - 30° right curved	24.1670.00
45° links gebogen - 45° left curved	24.1671.00
45° rechts gebogen - 45° right curved	24.1672.00
7° aufwärts gebogen - 7° upward curved	24.1673.00
7° abwärts gebogen - 7° downward curved	24.1674.00
15° aufwärts gebogen - 15° upward curved	24.1675.00
15° abwärts gebogen - 15° downward curved	24.1676.00

Breitmaulstanze, gerades Rohr
Square Punch wide, straight Tube

Ø 3,4 mm, Arbeitslänge 130 mm
Ø 3,4 mm, Working Length 130 mm



24.1665.00

Breitmaulstanze, gerades Rohr
Square Punch wide, straight Tube

Ø 3,4 mm, Arbeitslänge 130 mm
Ø 3,4 mm, Working Length 130 mm



24.1677.00

Breitmaulstanze, 90° rechts, gerades Rohr
Square Punch wide, 90° right, straight Tube

Ø 3,4 mm, Arbeitslänge 130 mm
Ø 3,4 mm, Working Length 130 mm



24.1666.00

Breitmaulstanze, 90° rechts, gerades Rohr
Square Punch wide, 90° right, straight Tube

Ø 3,4 mm, Arbeitslänge 130 mm
Ø 3,4 mm, Working Length 130 mm



24.1678.00

Breitmaulstanze, 90° links, gerades Rohr
Square Punch wide, 90° left, straight Tube

Ø 3,4 mm, Arbeitslänge 130 mm
Ø 3,4 mm, Working Length 130 mm



24.1667.00

Breitmaulstanze, 90° links, gerades Rohr
Square Punch wide, 90° left, straight Tube

Ø 3,4 mm, Arbeitslänge 130 mm
Ø 3,4 mm, Working Length 130 mm



24.1679.00

Faßzangen (Arthroskopie) Grasping Forceps (Arthroscopy)

A9

Faßzangen, gerieftes Maul
Grasping Forceps, serrated Jaw

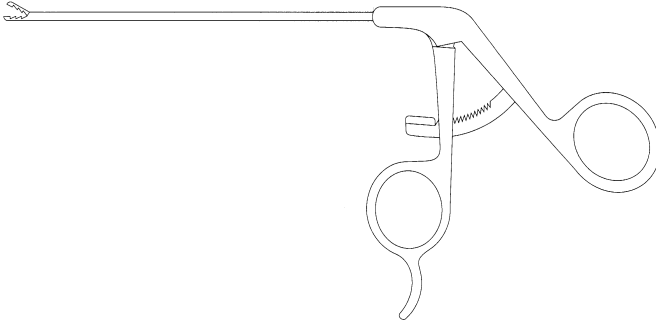

Faßzange
Grasping Forceps
Arbeitslänge 130 mm - Working Length 130 mm

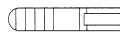
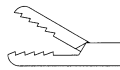

Ø	Griff mit Raste Handle with Ratched	Griff ohne Raste Handle without Ratched
2,7 mm	24.1700.00	24.1701.00
3,5 mm	24.1702.00	24.1703.00

Faßzange, 1:2 Zähne
Grasping Forceps, 1:2 Teeth
Arbeitslänge 130 mm - Working Length 130 mm

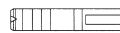
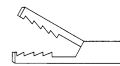

Ø	Griff mit Raste Handle with Ratched	Griff ohne Raste Handle without Ratched
2,7 mm	24.1704.00	24.1705.00
3,5 mm	24.1706.00	24.1707.00

Biopsie-Faßzange
Biopsy and Grasping Forceps
Arbeitslänge 130 mm - Working Length 130 mm

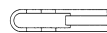
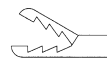

Ø	Griff mit Raste Handle with Ratched	Griff ohne Raste Handle without Ratched
2,7 mm	24.1708.00	24.1709.00
3,5 mm	24.1710.00	24.1711.00

Schlesinger Meniskus-Faßzange
Schlesinger Meniscus Grasping Forceps
Arbeitslänge 130 mm - Working Length 130 mm

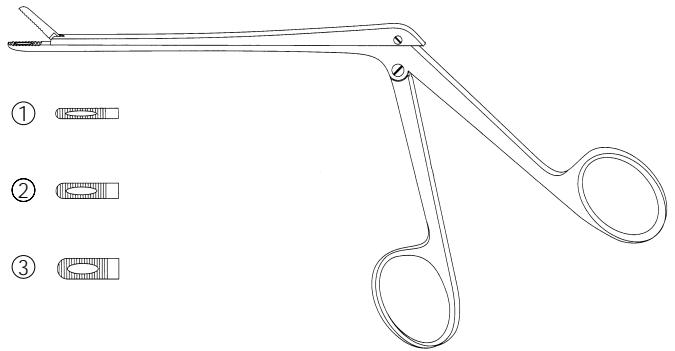

① 2 x 10 mm	24.1713.00
② 3 x 10 mm	24.1714.00
③ 4 x 10 mm	24.1715.00

Faßzange mit Raste, 1:2 Zähne
Grasping Forceps with Ratchet, 1:2 Teeth
Arbeitslänge 110 mm - Working Length 110 mm

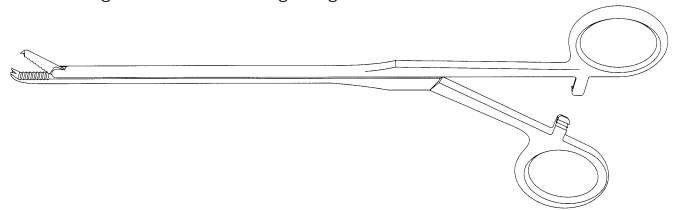

24.1712.00

Saugstanzen, Retrograde Stanzen (Arthroskopie)
Suction Punch, Retrograde Punch (Arthroscopy)

A10

Saugstanze, Ø 4,8 mm - Suction Punch, Ø 4,8 mm

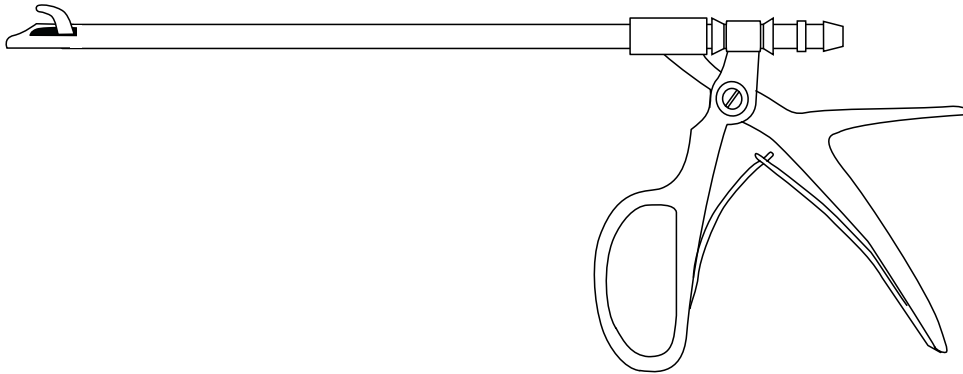

24.1716.00

Retrograde Stanze, starr - Retrograde Punch, motionless

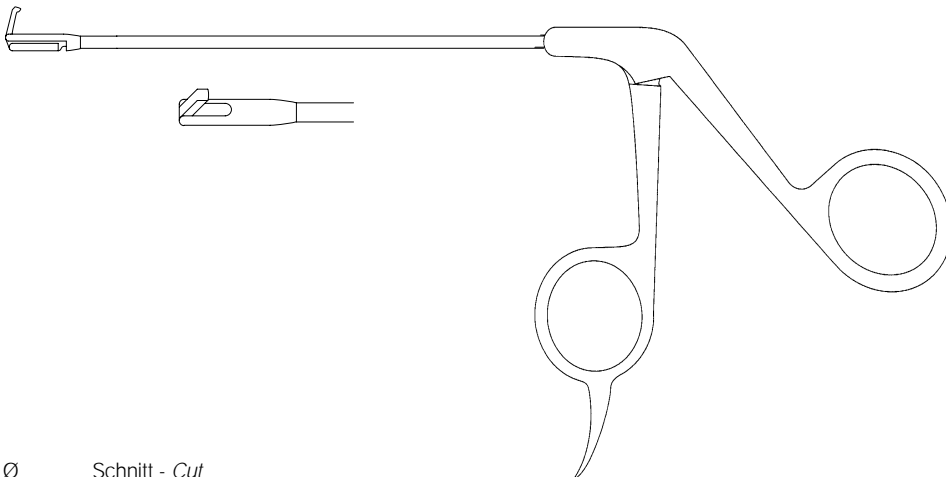

Ø	Schnitt - Cut	
4,5 mm	2,5 x 6,5 mm rechts schneidend - right cutting	24.1720.00
3,5 mm	2,0 x 5,0 mm rechts schneidend - right cutting	24.1721.00
4,5 mm	2,5 x 6,5 mm links schneidend - left cutting	24.1722.00
3,5 mm	2,0 x 5,0 mm links schneidend - left cutting	24.1723.00
4,5 mm	2,5 x 6,5 mm aufwärts schneidend - upward cutting	24.1724.00
3,5 mm	2,0 x 5,0 mm aufwärts schneidend - upward cutting	24.1725.00
4,5 mm	2,5 x 6,5 mm abwärts schneidend - downward cutting	24.1726.00
3,5 mm	2,0 x 5,0 mm abwärts schneidend - downward cutting	24.1727.00

Arthroskopie Arthroscopy

A12

Arthroskopie-Beinhalter - *Arthroscopy Action Leg Holder*

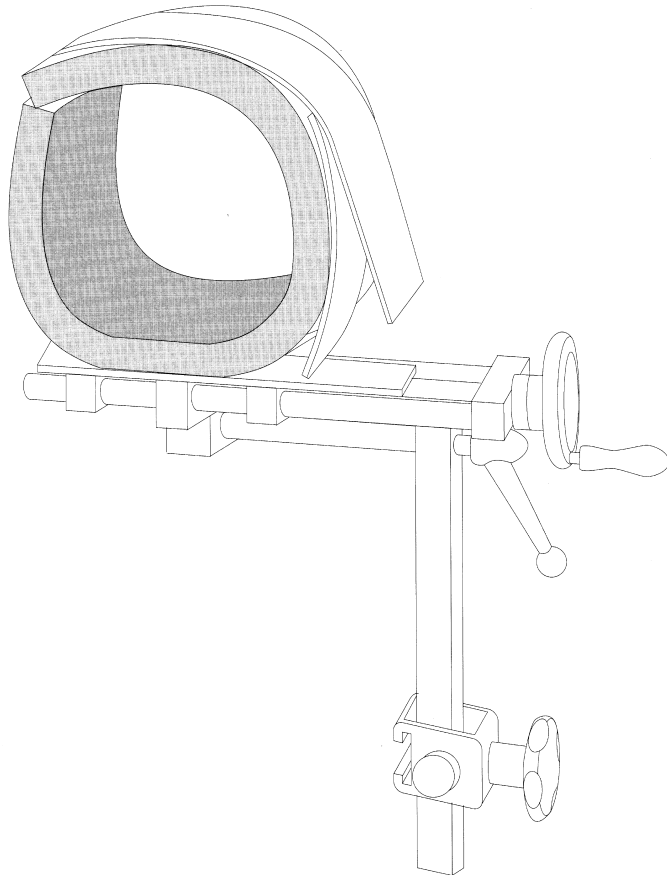

Beinhalter dreh- und schwenkbar
Swivel and revolving Action Leg Holder 05.0051.00

Schnellbefestigungskolben 25 mm
Quick release clamp 25 mm 05.0052.00

Schnellbefestigungskolben 30 mm
Quick release clamp 30 mm 05.0053.00

Arthroskopiemodell vom Kniegelenk
Arthroscopy Knee-Joint Model

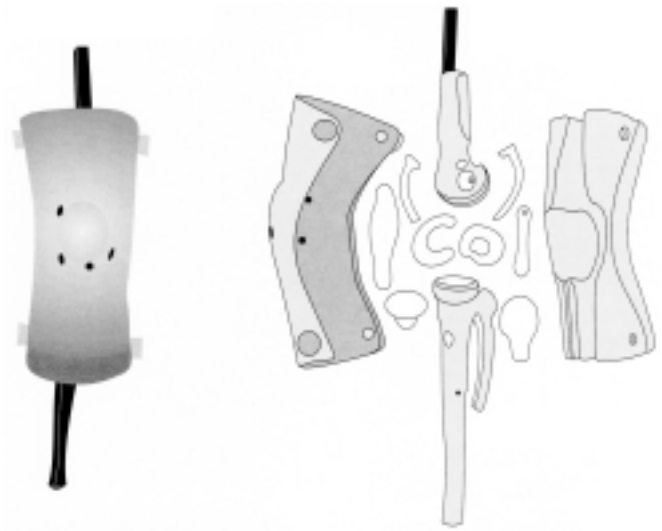

Modell allein - *Model only* 05.0054.00

Modell im Aluminiumkoffer - *Model in an Aluminium Suitcase* 05.0055.00

Haltevorrichtung - *Mounting Support* 05.0056.00

Arthroskopieren mit den neuen **STAFEX** Handinstrumenten von baholzer – Präzision bis ins Detail.

*Doing arthroscopy with the new **STAFEX** Instruments from baholzer - precise up to details.*

STAFEX bedeutet arthroskopische Instrumente auf höchstem Niveau basierend auf einer Technologie von gleitenden Radien, einer direkten Kraftübertragung und außergewöhnlichen Schnittleistungen. Ohne verschleiß- und reparaturanfälligen Stiften und Miniachsen. Lieferbar mit unterschiedlichen Handgriffen ja nach Anwendung und persönlichem Geschmack.

***STAFEX** means arthroscopic instruments on highest level caused on a technology with sliding radiuses, direct force transmission and extraordinary cutting performance, all without problematic jaw axes and pins they may break because of overload. Different handles are available based on intended use or personal liking.*

Technik:

Keine Verwendung von Stiften oder Miniachsen

Große ergonomisch geformte Handgriffe

Kraftübertragung durch Axialschiene und U-Führung

Industriell gefertigte CNC Maulteile

Individuell eingestellte und geschärfte Schnittkanten

Vorteile:

keine Brüche der Maulteilachse

Minimierter Kraftaufwand
Angenehmes Arbeiten

Kein Kraftverlust, direktes Feedback vom distalen Ende

Präzision im Instrument ermöglicht präzises arbeiten am Patient. Gleiche Instrument auch bei Ersatz oder Wechsel im Sieb

Höchste Schneidleistung bei jedem Instrument

Technologie:

Pinless hinge design

Ergonomic and nicely sized handles

Transmission of force via axial steel base plate

Industrial manufactured CNC jaw parts

Every instrument has a hand sharpen cutting edge

Benefits:

No breaks on the jaw parts

Minimal force, comfortable work

No loss of force, direct feedback from the distal part





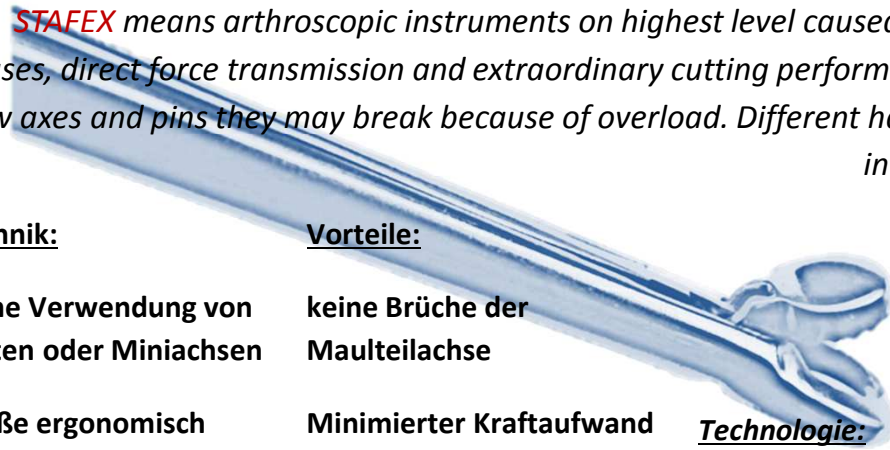

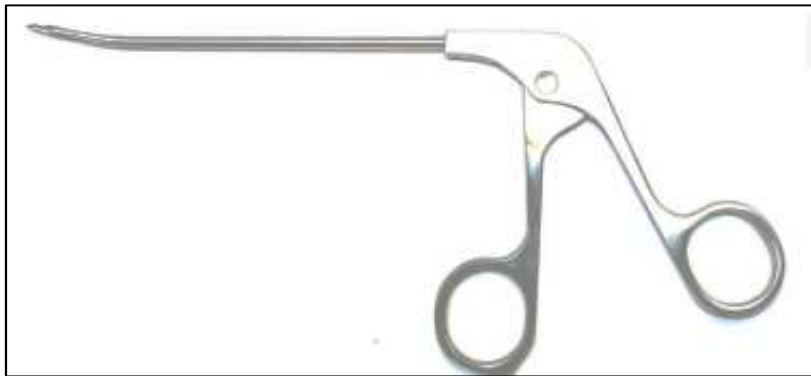



Precision on instrument is the base for a precise work on the patient. Comparability of the single instruments

Highest cutting performance on every punch

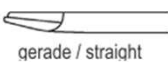







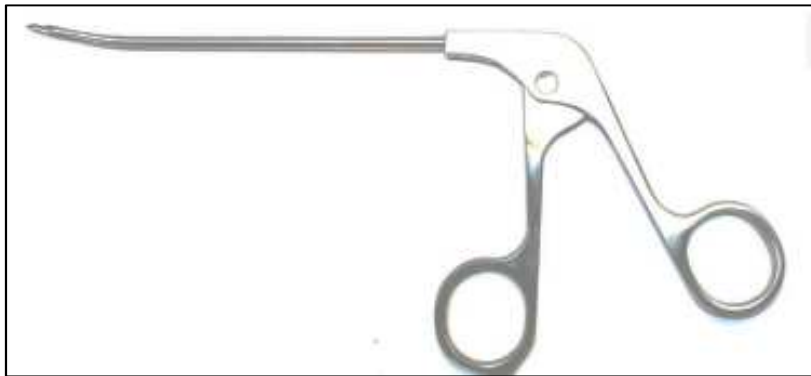



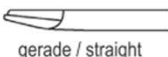
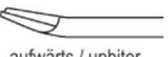

STAFEX Ringhandgriff / STAFEX Loop Handle

				
Beschreibung <i>Description</i>	Korbstanze mit Schaufel <i>Punch with scoop</i>	Korbstanze schlank <i>Punch small</i>	Korbstanze gestreckt <i>Punch narrow</i>	Korbstanze oval <i>Punch oval</i>
Maulunterseite (Höhe) <i>Lower jaw (height)</i>	1,5 mm	1,5 mm	1,5 mm	1,5 mm
Maulteil (Gesamthöhe) <i>Jaw (total height)</i>	2,0 mm	2,0 mm	2,0 mm	2,0 mm
 gerade / straight	24-2510-11	24-2511-11	24-2512-11	24-2513-11
 aufwärts / upbiter	24-2510-21	24-2511-21	24-2512-21	24-2513-21
 aufgebogen / upswept	24-2510-31	24-2511-31	24-2512-31	---
 aufwärts links / upbiter left	24-2510-41	24-2511-41	24-2512-41	---
 aufwärts rechts / upbiter right	24-2510-51	24-2511-51	24-2512-51	---
 links / left	24-2510-61	24-2511-61	24-2512-61	24-2513-61
 rechts / right	24-2510-71	24-2511-71	24-2512-71	24-2513-71
Arbeitslänge 12,0 cm / Working Length 4 ¾"				

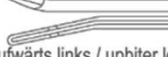





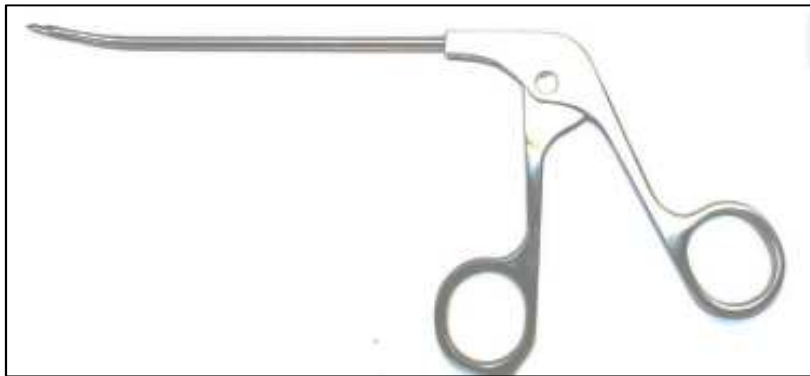

STAFEX Ringhandgriff / *STAFEX Loop Handle*

				
Beschreibung <i>Description</i>	Schaufelstanze flach, abgesetzt <i>Bucket Punch flat</i>	Schaufelstanze abgesetzt <i>Bucket Punch</i>	Scherenstanze <i>Scissor Punch</i>	Retrograde Stanze Rechts / right <i>Back Biter Punch</i>
Maulunterseite (Höhe) <i>Lower jaw (height)</i>	1,0 mm	1,5 mm	1,5 mm	---
Maulteil (Gesamthöhe) <i>Jaw (total height)</i>	2,0 mm	2,0 mm	2,0 mm	2,3 mm
 gerade / straight	24-2520-11	24-2521-11	24-2530-11	24-2541-11
 aufwärts / upbiter	24-2520-21	24-2521-21	24-2530-21	---
 aufgebogen / upswept	24-2520-31	24-2521-31	24-2530-31	---
 aufwärts links / upbiter left	---	---	---	---
 aufwärts rechts / upbiter right	---	---	---	---
 links / left	---	---	---	---
 rechts / right	---	---	---	---
Arbeitslänge 12,0 cm / Working Length 4 ¾"				



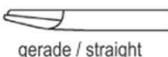
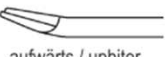



STAFEX Ringhandgriff / STAFEX Loop Handle

				
Beschreibung <i>Description</i>	Retrograde Stanze Links / left <i>Back Biter Punch</i>	Super Faszange <i>Super Forceps</i>	Alligator Faszange <i>Alligator Forceps</i>	Faszange mit Fenster <i>Window Forceps</i>
Maulunterseite (Höhe) <i>Lower jaw (height)</i>	---	---	---	---
Maulteil (Gesamthöhe) <i>Jaw (total height)</i>	2,3 mm	4,5 mm	2,7 mm / 3,2 mm	2,7 mm / 3,4 mm
 gerade / straight	24-2542-11	24-2558-11	24-2550-11-01 / 24-2550-11-02	24-2555-11-01 24-2555-11-02
 aufwärts / upbiter	---	---	---	---
 aufgebogen / upswept	---	---	---	---
Arbeitslänge 12,0 cm / Working Length 4 ¾"				

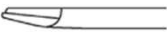

STAFEX Rotationsgriff / *STAFEX Turning Handle*

	 rechts / right	 links / left	 rechts / right	 links / left
Beschreibung <i>Description</i>	Korbstanze 90° Rechts / right Basket Punch 90°	Korbstanze 90° Links / left Basket Punch 90°	Korbstanze 90° Rechts / right Basket Punch 90°	Korbstanze 90° Links / left Basket Punch 90°
Maulunterseite (Höhe) <i>Lower jaw (height)</i>	---	---	---	---
Maulteil (Gesamthöhe) <i>Jaw (total height)</i>	2,2 mm	2,2 mm	3,4 mm	3,4 mm
 gerade / straight	24-2514-14-01	24-2515-14-01	24-2514-14-02	24-2515-14-02











Unser Rotationshandgriff ermöglicht es auch bei Korbstanzen 90° in der gewohnten Griffhaltung zu arbeiten. Die Kraftübertragung ist optimal. Ein umgewöhnen auf Axial- oder Zigarrengriffe ist nicht notwendig.

Our Rotationhandle for the Basket Punches 90° gives you the advantage of working in the common position for punching instruments. The force transmission from the handle to the distal tip is ideal. A change on your work position caused by Axial- or Cigar-Handles isn't necessary.

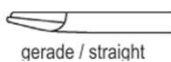
Arbeitslänge 12,0 cm / Working Length 4 ¾"

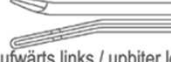









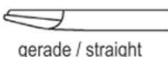
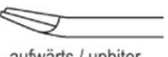

STAFEX Komfortgriff / STAFEX Ergonomie Handle

				
Beschreibung <i>Description</i>	Korbstanze mit Schaufel <i>Punch with scoop</i>	Korbstanze schlank <i>Punch small</i>	Korbstanze gestreckt <i>Punch narrow</i>	Korbstanze oval <i>Punch oval</i>
Maulunterseite (Höhe) <i>Lower jaw (height)</i>	1,5 mm	1,5 mm	1,5 mm	1,5 mm
Maulteil (Gesamthöhe) <i>Jaw (total height)</i>	2,0 mm	2,0 mm	2,0 mm	2,0 mm
 gerade / straight	24-2510-12	24-2511-12	24-2512-12	24-2513-12
 aufwärts / upbiter	24-2510-22	24-2511-22	24-2512-22	24-2513-22
 aufgebogen / upswept	24-2510-32	24-2511-32	24-2512-32	---
 aufwärts links / upbiter left	24-2510-42	24-2511-42	24-2512-42	---
 aufwärts rechts / upbiter right	24-2510-52	24-2511-52	24-2512-52	---
 links / left	24-2510-62	24-2511-62	24-2512-62	24-2513-62
 rechts / right	24-2510-72	24-2511-72	24-2512-72	24-2513-72
Arbeitslänge 12,0 cm / Working Length 4 ¾"				

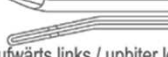







STAFEX Komfortgriff / STAFEX Ergonomie Handle

				
Beschreibung <i>Description</i>	Schaufelstanze flach, abgesetzt <i>Bucket Punch flat</i>	Schaufelstanze abgesetzt <i>Bucket Punch</i>	Scherenstanze <i>Scissor Punch</i>	Retrograde Stanze Rechts / right <i>Back Biter Punch</i>
Maulunterseite (Höhe) <i>Lower jaw (height)</i>	1,0 mm	1,5 mm	1,5 mm	---
Maulteil (Gesamthöhe) <i>Jaw (total height)</i>	2,0 mm	2,0 mm	2,0 mm	2,3 mm
 gerade / straight	24-2520-12	24-2521-12	24-2530-12	24-2541-12
 aufwärts / upbiter	24-2520-22	24-2521-22	24-2530-22	---
 aufgebogen / upswept	24-2520-32	24-2521-32	24-2530-32	---
 aufwärts links / upbiter left	---	---	---	---
 aufwärts rechts / upbiter right	---	---	---	---
 links / left	---	---	---	---
 rechts / right	---	---	---	---
Arbeitslänge 12,0 cm / Working Length 4 ¾"				



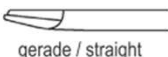
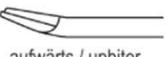



STAFEX Komfortgriff / STAFEX Ergonomie Handle

				
Beschreibung <i>Description</i>	Retrograde Stanze Links / left <i>Back Biter Punch</i>	Super Faszange <i>Super Forceps</i>	Alligator Faszange <i>Alligator Forceps</i>	Faszange mit Fenster <i>Window Forceps</i>
Maulunterseite (Höhe) <i>Lower jaw (height)</i>	---	---	---	---
Maulteil (Gesamthöhe) <i>Jaw (total height)</i>	2,3 mm	4,5 mm	2,7 mm / 3,2 mm	2,7 mm / 3,4 mm
 gerade / straight	24-2542-12	24-2558-12	24-2550-12-01 / 24-2550-12-02	24-2555-12-01 24-2555-12-02
 aufwärts / upbiter	---	---	---	---
 aufgebogen / upswept	---	---	---	---
Arbeitslänge 12,0 cm / Working Length 4 ¾"				

Ohne Bild / Without Picture

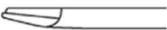
STAFEX Ringhandgriff mit Sperre / *STAFEX Loop Handle with Ratchet*

				
Beschreibung <i>Description</i>	Super Faszange <i>Super Forceps</i>	Alligator Faszange <i>Alligator Forceps</i>	Faszange mit Fenster <i>Window Forceps</i>	
Maulunterseite (Höhe) <i>Lower jaw (height)</i>	---	---	---	
Maulteil (Gesamthöhe) <i>Jaw (total height)</i>	4,5 mm	2,7 mm / 3,2 mm	2,7 mm / 3,4 mm	
 gerade / straight	24-2558-12	24-2550-12-01 / 24-2550-12-02	24-2555-12-01 24-2555-12-02	
 aufwärts / upbiter		---	---	
 aufgebogen / upswept		---	---	
Arbeitslänge 12,0 cm / Working Length 4 ¾"				